

This is a NEW Co-Culture System and Vessel Technology!!



UniWells™ Horizontal Co-Culture Plate

UniWells™ Horizontal Co-Culture Plate is an ideal co-culture device that connects two wells laterally. The horizontal connection provides easy viewing of cells in both wells simultaneously using various types of microscopes. It is a versatile tool for studying cell-cell interactions such as transport, migration, and invasion.

Features

1. Simultaneous observation using a time-lapse microscope
2. Cells are cultured under the same condition (used same material on the bottom)
3. Filters of any membrane types and pore sizes are usable
4. Both wells are independent (connect in a free combination)



UniWells™ Horizontal Co-Culture Plate (1Set)
(384-14421)

Code No.	Product Name	How to	Package Size
384-14421	UniWells™ Horizontal Co-Culture Plate	Well-Culture	10 Sets
381-14431	UniWells™ Filter 0.03μm	Filter (Pore Size 0.03μm)	50 Sheets
388-14441	UniWells™ Filter 0.6μm	Filter (Pore Size 0.6μm)	50 Sheets
388-17001	UniWells™ Adapter 96	16Well Holder	1 EA
380-19261	UniWells™ Filter 1.2μm	Filter (Pore Size 1.2μm)	50 Sheets

Excellent points

1) Both cells can be cultured under the same medium volume

Conventional co-culture plate

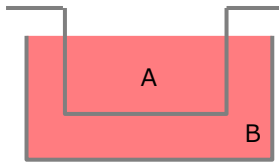

A:B = 1:3

Medium volume in A is more than in B and cell secreted factors A are diluted in B.

UniWells™

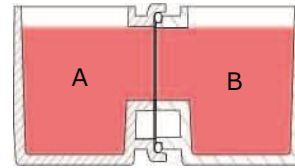

A:B = 1:1

Medium volume are the same between A and B.

2) Filter is prevented from being clogged by cells

Conventional co-culture plate

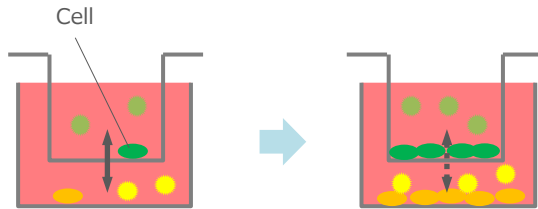

The filter is clogged by cells cultured in the upper well, which leads to interfering with the migration of cell secreted factors between the upper and lower wells.

UniWells™

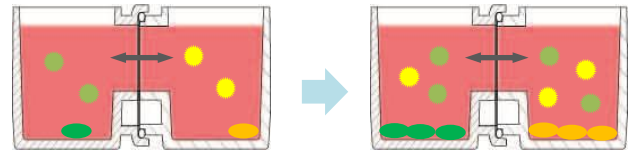

The filter is NOT clogged by cells.

Instructions for use

Connected use

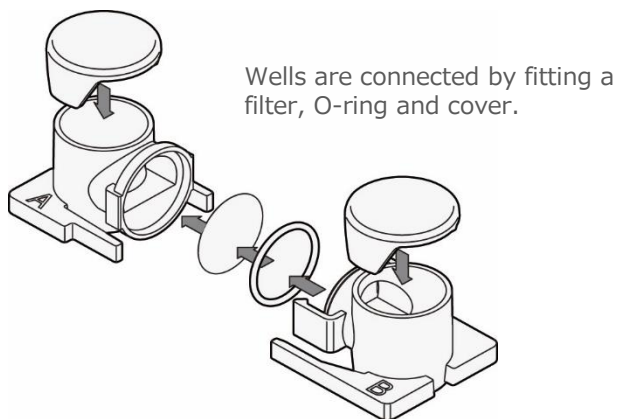

Wells are connected by fitting a filter, O-ring and cover.

Connection methods are as below;

- Connect the wells cultured independently by aspirating the culture solution once.
- Connect first and increase the volume of the culture solution to achieve co-culture.

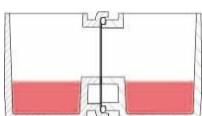

Non-co-culture

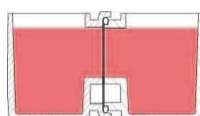

Co-culture

Single use

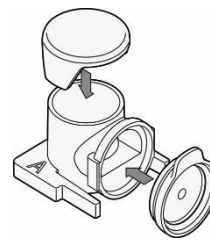

Fit a common cover and cover to a well.

Use in a microscope

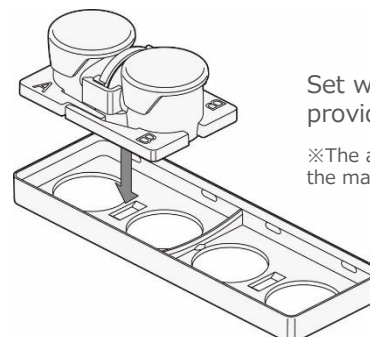

Set wells to the adapter provided.

※The adapter is attached to the main unit.

Well size & Medium volume

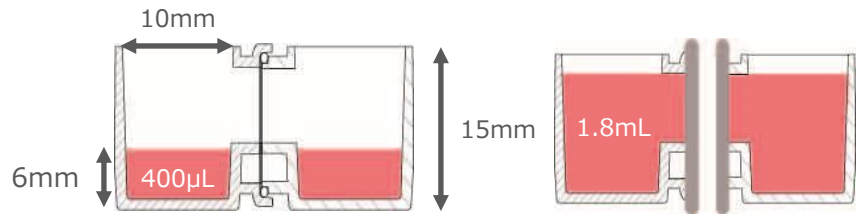

A medium volume of less than 400 µL is not shared between the wells.

The maximum medium volume on each well is 1.8 mL.

Video

The video how to use UniWells™ is disclosed.



How to use ICCP



<https://www.youtube.com/watch?v=KbzXKoWpxAQ>

Example of use

Comparison of permeability testing of exosome between conventional co-culture plate and UniWells™

1. Cells were seeded to be the same cell numbers into the upper well in conventional co-culture plate and one side well in Uniwells™.
2. Co-culture started after 24 hours from cell seeding.
3. Exosome densities of the cell side and medium side were analyzed.

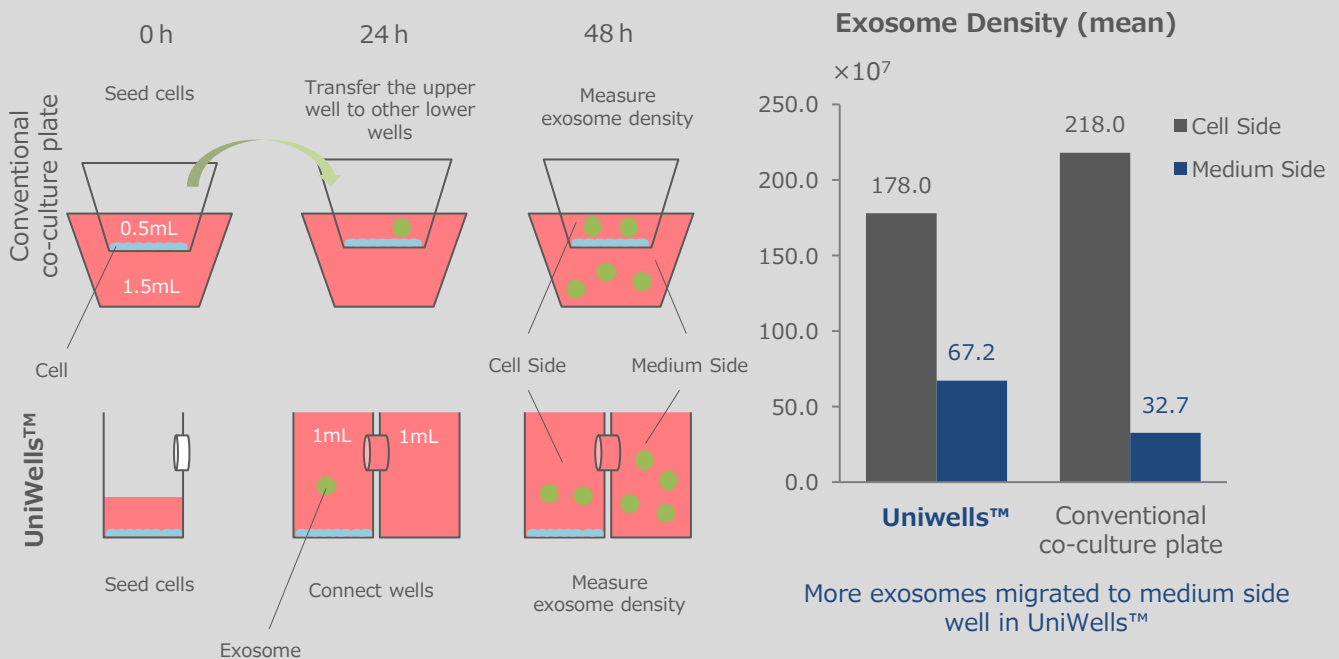

Uptake of exosomes

UniWells™ Horizontal Co-Culture Plate enables the observation that exosomes derived from cell B permeate the filter and are taken up by cell A.

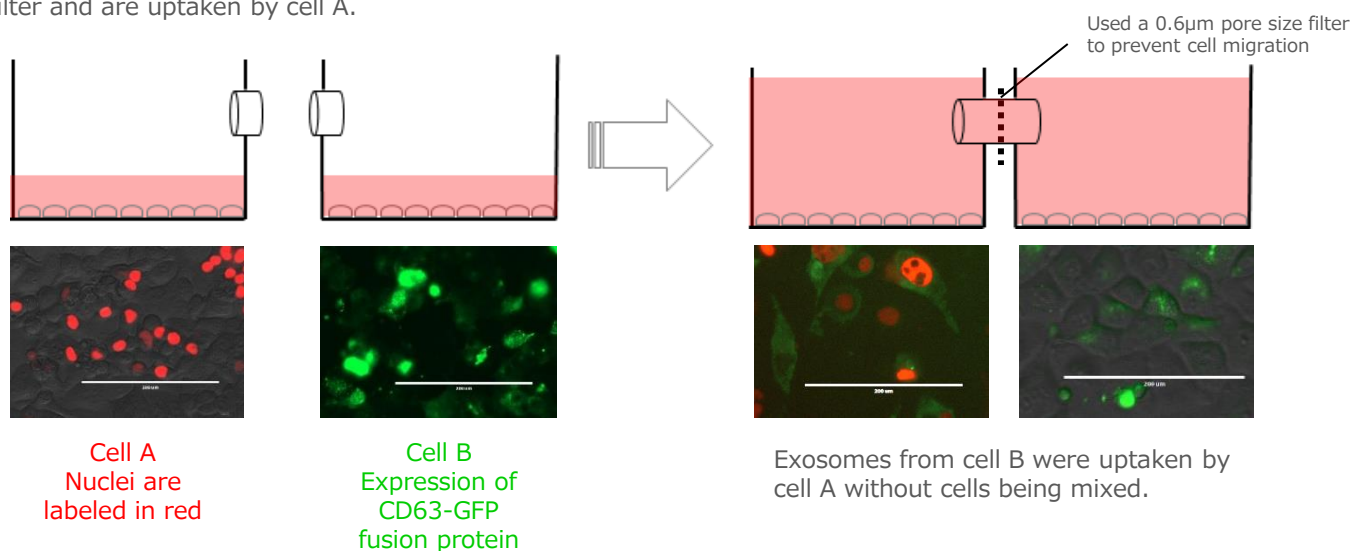

FAQ

What is UniWells™ made of?

The main body and common cover are made of polystyrene and low density polyethylene, respectively. UniWells™ filter, which is sold separately, is made of polycarbonate.

Is Uniwells™ Sterilized?

Uniwells™ is sterilized by electron beam sterilization. Do not sterilize it by autoclaving.

Are the main body surfaces coated with anything?

No, they are not coated. Coat the main body surfaces with attachment matrixes as needed.

How volume are cells seeded?

Manufacturer seeds 5×10^4 /mL NHDF and PANC-1 cell in a well added 190 µL medium. After 24h, the cell confluence is about 40-50%. But the best condition is needed to consider by user, because it is differed by using cells.

Manufacturer's HP

The web site created by manufacturer has many information about UniWells™.

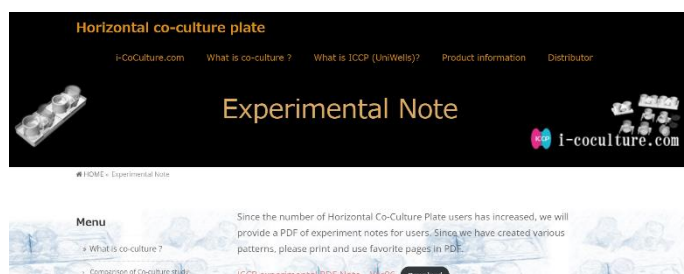

<https://i-coculture.com/>